

簡介

CS-732無線電子控制器(以下簡稱本產品)是自動開關控制器最佳幫手,採用RF高頻設計,有兩組繼電器模式提供使用者做各種設定,利用指撥開關即可設定密碼,簡單方便。CS-732電源供應部分共有三種型號,分別是DC 12V、AC 24V、AC 12V,可選擇不同之遙控器搭配:單按鍵遙控器(TX-F01)、雙按鍵遙控器(TX-F02)、四按鍵遙控器(TX-F04)。

外觀圖

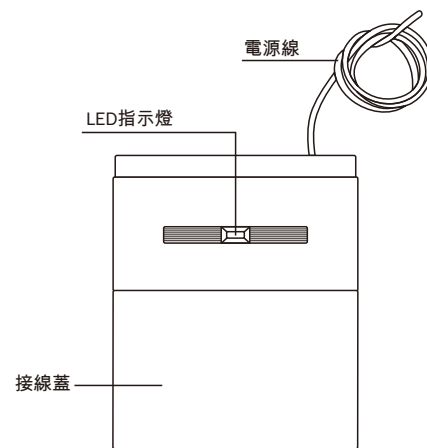

1

使用步驟

設定遙控器配對方式

本產品之功能模式共有10款,依照功能模式表選擇所需的遙控器,再依照不同之功能配對說明後便可使用。

步驟一：打開接線蓋

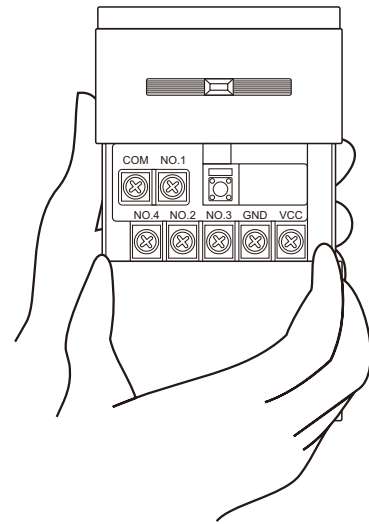

步驟二：接電源

接上電源,DC12V或DC24V(依照型號有所不同),接上電源後LED指示燈即慢閃。

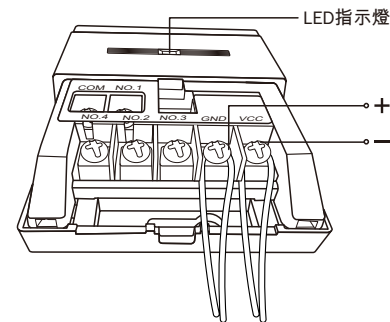

2

步驟三：

依照所需要的功能對照功能模式表調整主機之跳線帽是否接入或拔除,以及搖控器的設定按鍵。

跳線帽

依照功能模式表選擇跳線帽是否接入或拔除。

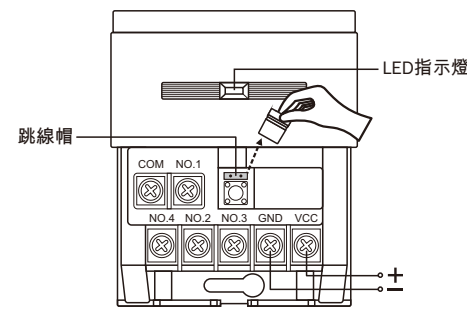

步驟四：設定鍵

按住設定鍵不放2秒過後LED急閃放開,即進入設定模式,此時依照功能模式表按下遙控器的設定鍵,設定完成後LED指示燈慢閃表示已經完成,主機會自動記憶並儲存。

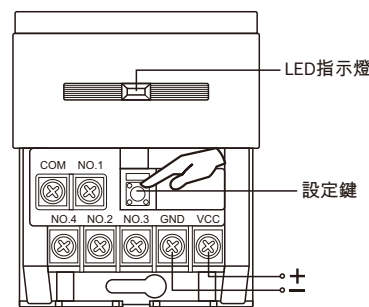

步驟五：鬆開端子台之螺絲

鬆開端子台之螺絲,將外部引線置入螺絲下方並鎖緊。

3

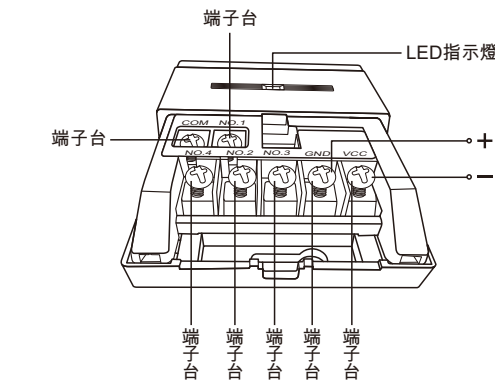

步驟六：功能測試

再依照所設定的功能測試,此時LED指示燈慢閃,即表示設定已完成。

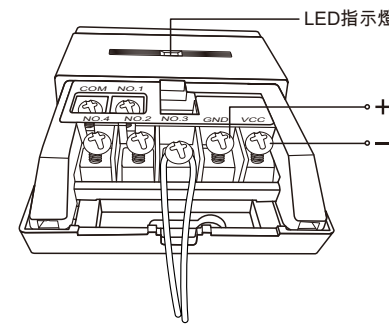

內部繼電器線路圖

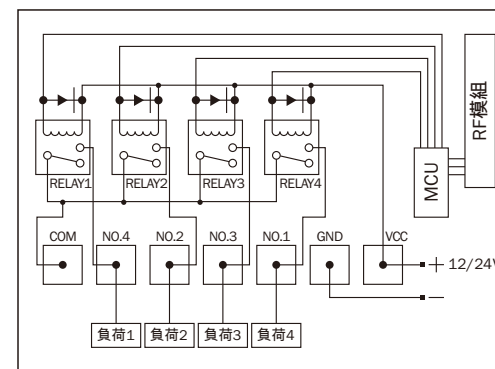

4

功能模式表

模式	功能	應用
模式1: 不需拔除跳線帽	每次按一次遙控器A鍵: 繼電器1: NO1接點與COM點導通2秒後斷開。 繼電器2: NO2接點與COM2點為導通-斷開-導通-斷開之循環方式(本功能常用於防盜器開關或電源開關)	電鎖門、防盜器外加遙控單點開關燈控制
模式2: 需拔除跳線帽	按一次A鍵繼電器1動作,長按A鍵2秒繼電器2才動作: 繼電器1 NO1接點與COM點接觸2秒後斷開。 繼電器2 NO2接點與COM2點接觸2秒後斷開。	雙接點同時動作之控制
模式3: 不需拔除跳線帽	每次按一次搖控器A鍵或B鍵: 繼電器1 NO1接點與COM1點導通2秒後斷開。 每按一次搖控器A鍵: 繼電器2 NO2接點與COM2點持續導通。 每按一次搖控器B鍵: 繼電器2 NO2接點與COM2點斷開。	公用電鎖門、自家電鎖門,公用ID不需判定,只要有遙控器都可開門



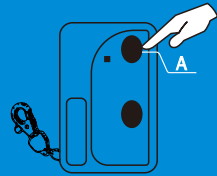
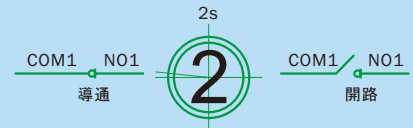
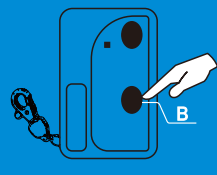
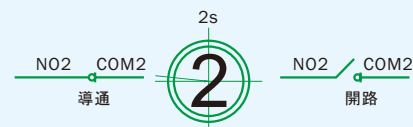

5

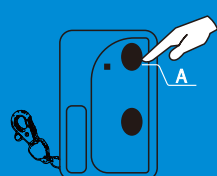
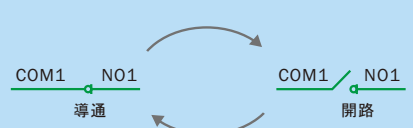
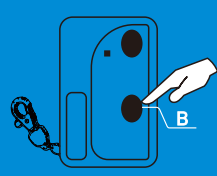
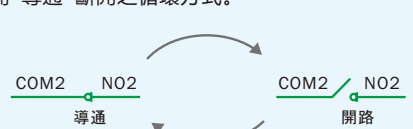

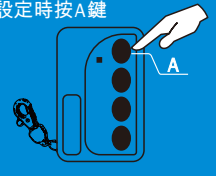
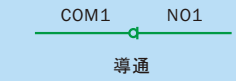
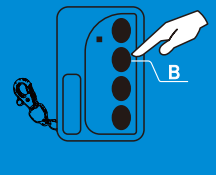
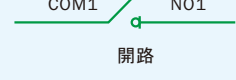
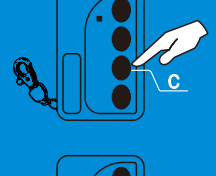
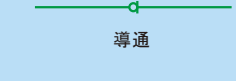
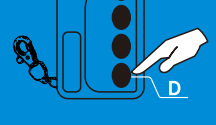
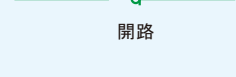

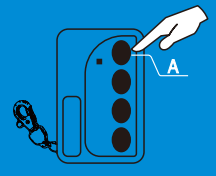
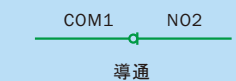
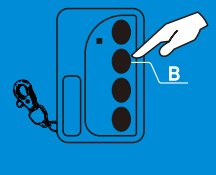
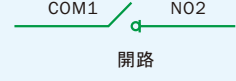
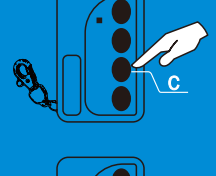

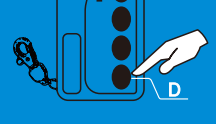

模式4: 不需拔除跳線帽	功能	應用
設定時按B鍵 	每次按一次遙控器A鍵，繼電器1: NO1接點與COM點導通2秒後即開路。 	自動門開啟、自動門鎖定後不允許自動門開門
	每次按一次遙控器B鍵，繼電器2: NO2接點與COM2點導通2秒後即開路。 	

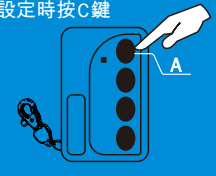
模式5: 需拔除跳線帽	功能	應用
設定時按A鍵 	每次按一次遙控器A鍵，繼電器1: NO1接點與COM1點導通2秒後即開路。 	需獨立兩組個別按鍵ON/OFF控制之開關
	每次按一次遙控器B鍵，繼電器2為導通-斷開-導通-斷開之循環方式。 	

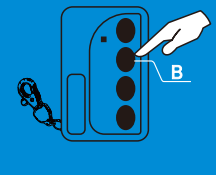
模式6: 需要拔除跳線帽	功能	應用
設定時按B鍵 	每按一次遙控器A鍵，繼電器1 NO1接點與COM1點導通-斷開-導通-斷開之循環方式。 	兩道門電鎖或滑升鐵捲門
	每按一次遙控器B鍵，繼電器2 NO2接點與COM2點導通-斷開-導通-斷開之循環方式。 	

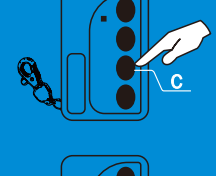
模式7: 不需拔除跳線帽	功能	應用
設定時按A鍵 	每次按一次遙控器A鍵，繼電器1: NO1接點與COM點導通。 	需獨立兩組個別按鍵ON/OFF控制之開關
	每次按一次遙控器B鍵，繼電器1: NO1接點與COM點不導通。 	
	每次按一次遙控器C鍵，繼電器2: NO2接點與COM點導通。 	
	每次按一次遙控器D鍵，繼電器2: NO2接點與COM點不導通。 	

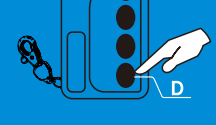
模式8: 不需拔除跳線帽	功能	應用
	每次按一次遙控器A鍵，繼電器2: NO2接點與COM1點導通。 	開關防盜、緊急求救、自動門控制
	每次按一次遙控器B鍵，繼電器2: NO2接點與COM1不導通。 	
	每次按一次遙控器C鍵，繼電器1: NO1接點與COM1點導通2秒後即開路。 	
	每次按一次遙控器D鍵，繼電器3: COM1與COM2接點導通2秒後即開路。 	

模式9: 不需拔除跳線帽	功能	應用
設定時按C鍵 	每次按一次遙控器A鍵，繼電器1為導通-斷開-導通-斷開之循環方式。 	4組開關，如電燈
	每次按一次遙控器B鍵，繼電器2為導通-斷開-導通-斷開之循環方式。 	
	每次按一次遙控器C鍵，繼電器4為導通-斷開-導通-斷開之循環方式。 	
	每次按一次遙控器D鍵，繼電器3為導通-斷開-導通-斷開之循環方式。 	

模式10: 不需拔除跳線帽	功能	應用
	每次按一次遙控器A鍵，繼電器1: NO1接點與COM點導通2秒後即開路。 	DC捲門或4接點觸控門
	每次按一次遙控器B鍵，繼電器2: NO2接點與COM點導通2秒後即開路。 	
	每次按一次遙控器C鍵，繼電器4: NO4接點與COM點導通2秒後即開路。 	
	每次按一次遙控器D鍵，繼電器3: NO3接點與COM點導通2秒後即開路。 	