

Wireless Digital CCD Camera Wireless Digital USB Receiver

2.4GHz GFSK Hopping

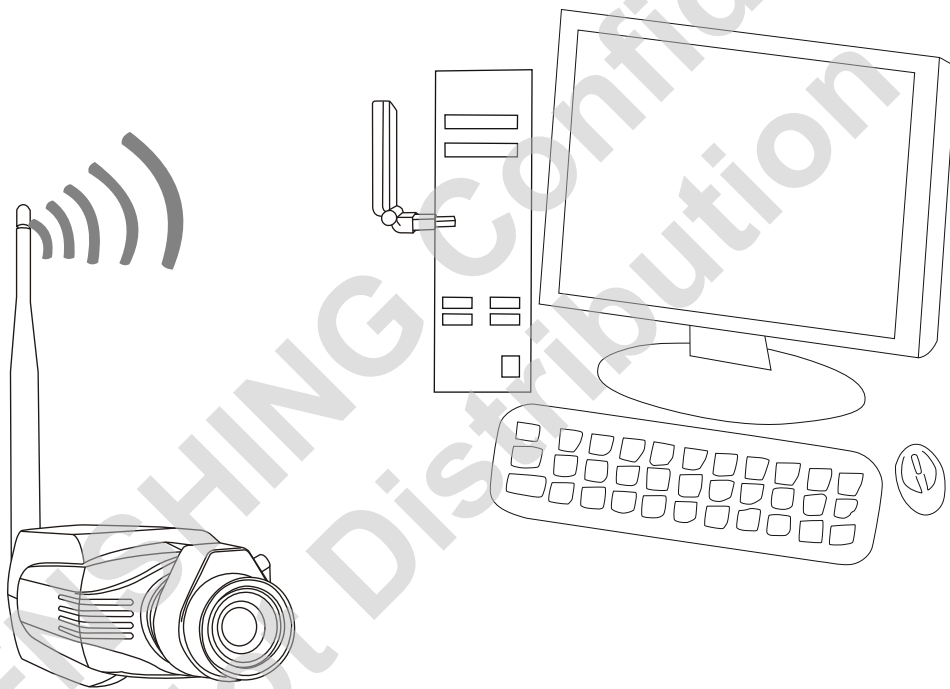

Model:WS-CQE-CCD(Wireless Digital CCD Camera)

Model:WS-VIDEO-USB(Wireless Digital USB Receiver)

Vision History

Version	Date	Changes
V1.01	Nov.01,2010	1 st Edition
V1.01	Dec.15,2010	2 st Edition
V1.01	Jan.17,2011	3 st Edition
V1.01	Feb.11,2011	4 st Edition
V2.01	Aug.17,2011	5 st Edition

Content

Important Event

Declaration	1
Warranty	1

Definition of Parts

Wireless Digital CCD Camera	2
Wireless Digital USB Receiver	2

Specification

Wireless Digital CCD Camera	3
Wireless Digital USB Receiver	3
RF Spec	3
Operating Environment	3

Dimension Diagram

Wireless Digital CCD Camera	4
Wireless Digital USB Receiver	5

Manipulating the Wireless Digital CCD Camera

Turn On	6
Pair	6
Recharge	6

Wireless Digital CCD Camera and Wireless Digital USB Receiver

Install	7
Setup	9
Pair	19
Application	21
Internet Surveillance	25
Abnormal Test	26

FCC Consistent Declaration(U.S.A. Only)

Administrative Regulations on Low Power Radio Waves Radiated Devices

- 1、 This product is in general use for the equipment on the premise of the development, design, manufacture. Do not use that require high security purposes, such as machinery or medical, aviation equipment, machinery and transport-related deaths are directly or indirectly related to the system.
- 2、 This product should be in this brochure by the instructions of the types and rated voltage power under the current proper use. If violation of this statement by the safety records of the supply operation, I am afraid our company cannot afford any of the responsibility.
- 3、 Do not self-decomposition, alteration, repair of the products also will cause fire, electric shock, fault, and dangerous. In addition, their decomposition, alteration, repair the product, failure is not within the scope of warranty.
- 4、 The products are not waterproof, so please do not use and touch water. Take off and on also please note. Rain, spray, drinks, steam, sweat may be a failure.
- 5、 Use of this product, please be sure to use according to the statement recorded by the use of methods to operate. Please do not violate particular attention to the matter reminded to use.
- 6、 Please respect this statement recorded by the note. When consumers in contravention of this statement recorded note of the operation, I am afraid our company could not shoulder any responsibility.
- 7、 Products are defective, the Company will be responsible for free to amend the flaws, or to the same flawless product or its equivalent products in exchange. However, the Company does not assume based on the requirements of the flaw and loss responsibility.
- 8、 The Company reserves the right to retain without notice to users of the cases, the product of hardware / software (version upgrade) is with the right to edit.

Declaration This product provides different frequency for user selection to meet different telecommunication regulation and FCC/NCC on different countries.

Warranty The warranty time is within one year from purchased date. The warranty scope are used in normal situation and none vandalism. (Some function harmful out of warranty scope and Vandalism are Un-warranty).

Un-warranty Scope Description

- 1、 Because the natural disaster, accident or human factor to cause the bad damage.
- 2、 Violate the product instruction manual to cause the damage of the products.
- 3、 The improper assemble causes damage.
- 4、 The products used the unsanctioned accessory to cause damaged.
- 5、 Overstep the allowed used environment to cause the products damaged.

Contact Us

WENSHING ELECTRONICS CO., LTD.

No.82, Chong De St. 11054 Shin Yi Dist., Taipei, Taiwan

Tel: +886-2-27353055

Fax: +886-2-27328813

- Wireless Digital CCD Camera

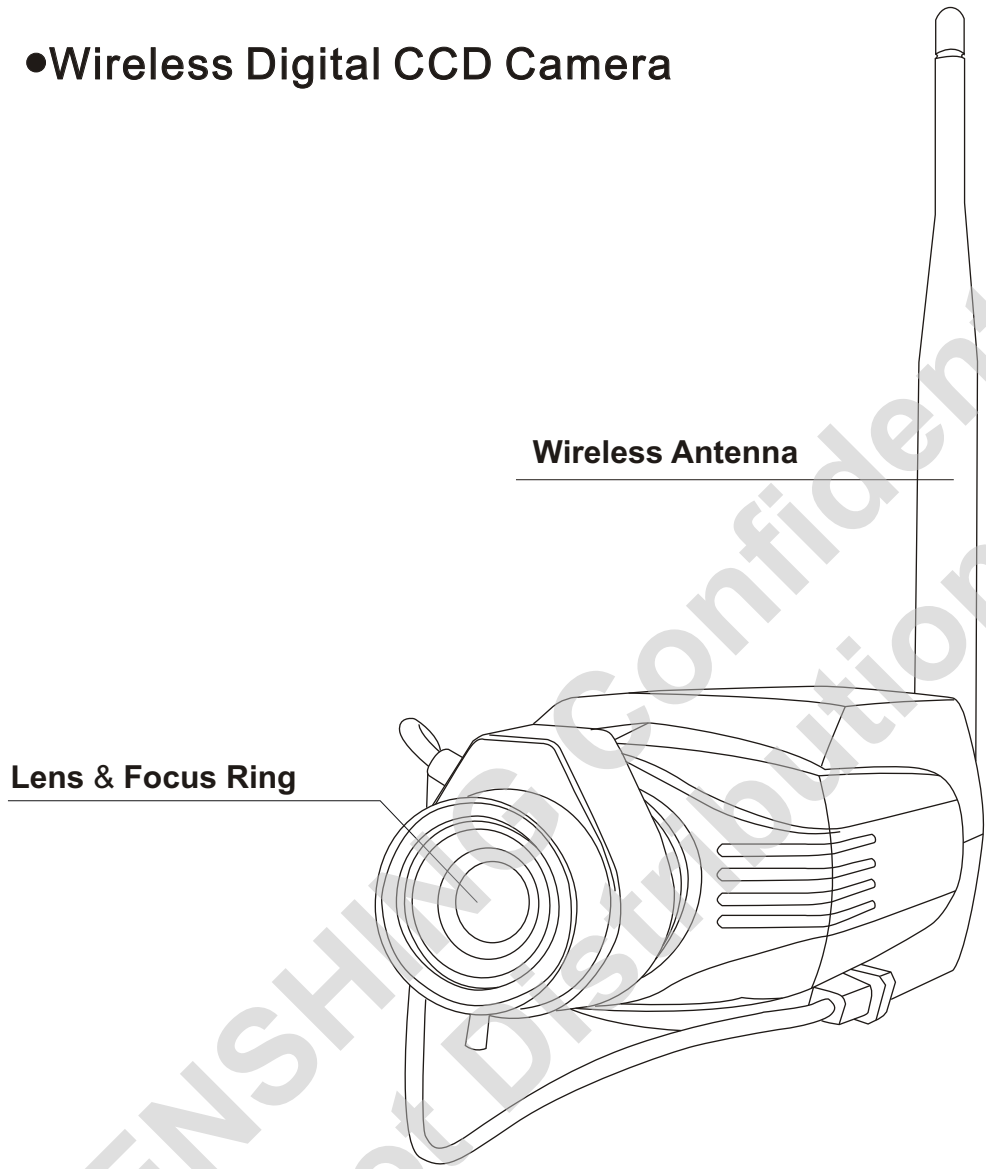

- Wireless Digital USB Receiver

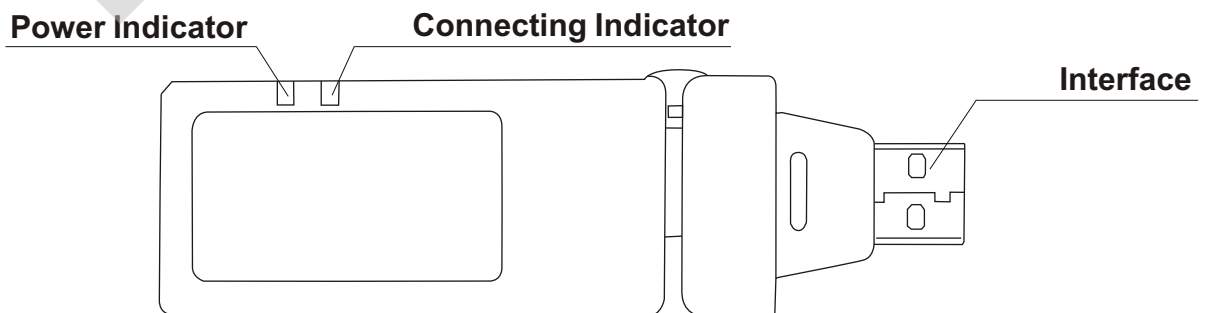

●Wireless Digital CCD Camera

Dimension: 140mm(L) * 68mm(W) * 60mm(H)

Weight: 520g(Lens/Battery/Antenna included)

Sensor:1/3"CCD sensor

Lens: Manual DC 3.5~8mm Varifocal Auto Iris Lens, F1.4

Omni directional Microphone

Battery: Built in 3000mA Li-ion battery

Operation period: 1 hour

Power supply: B Type Mini USB DV 5V/1A

●Wireless Digital USB Receiver

Dimensions: 106mm(L) * 28.1mm(W) * 10.9mm(H)

Weight: 22.6g

Support system: Microsoft Windows 2000/XP/Vista/WIN7

Resolution:

4-split screen: 5~8 frames at 320x240(QVGA)

Single screen: 10~16 frames at 640x480(VGA)

●RF Spec

Frequency : ISM 2400~2483MHz hopping

Transmission Power : 100mW (20dBm)

Modulation Mode : GFSK

●Operating Environment

Operating Temperature : 0°C~+50°C

Memorizing Temperature : -10°C~+60°C

●Certification

FCC Wireless Digital USB Receiver : OYQWSVIDEOUSB

NCC Wireless Digital USB Receiver : CCAB10LP5660T5

●Wireless Digital CCD Camera

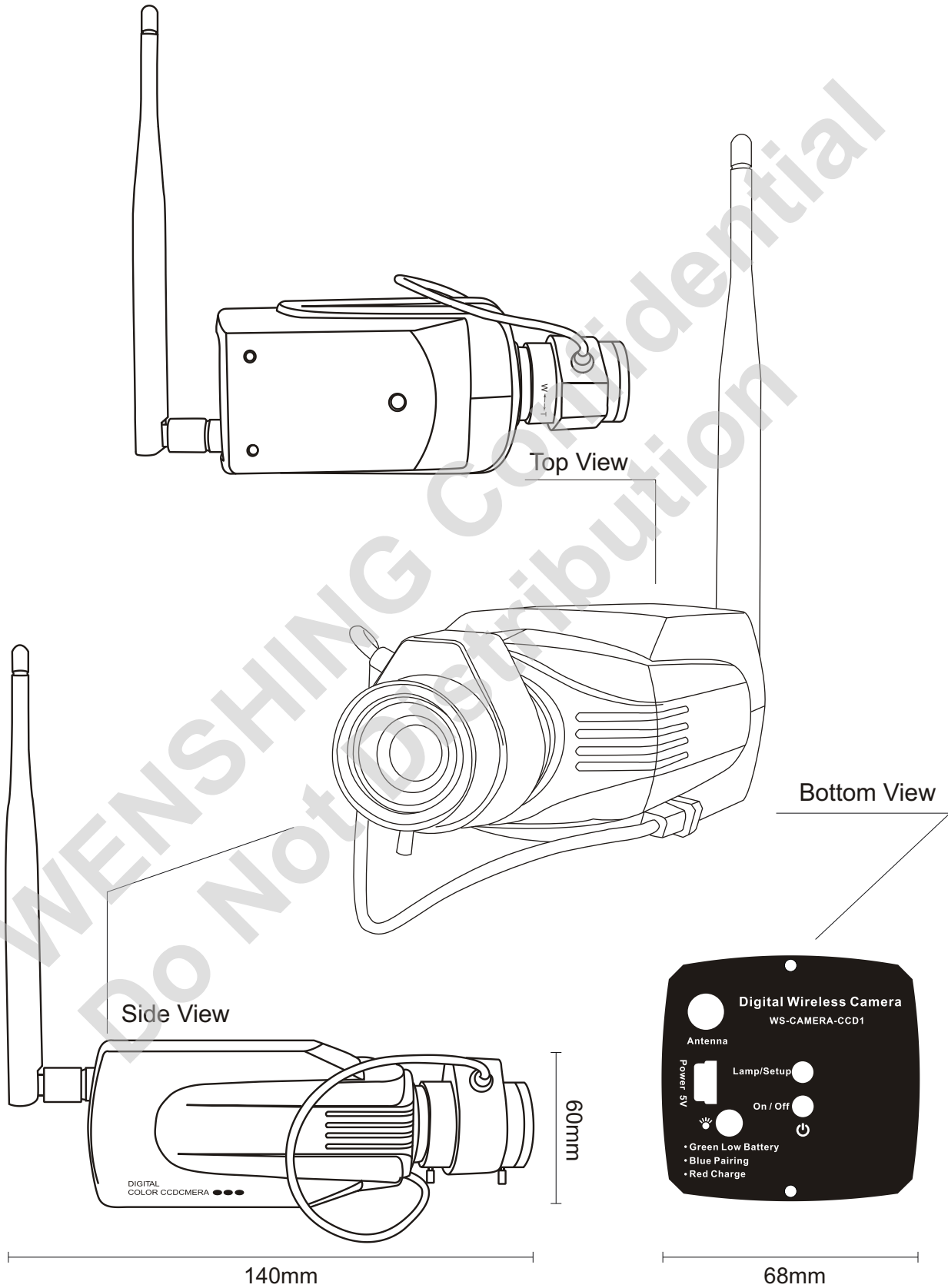

●Wireless Digital USB Receiver

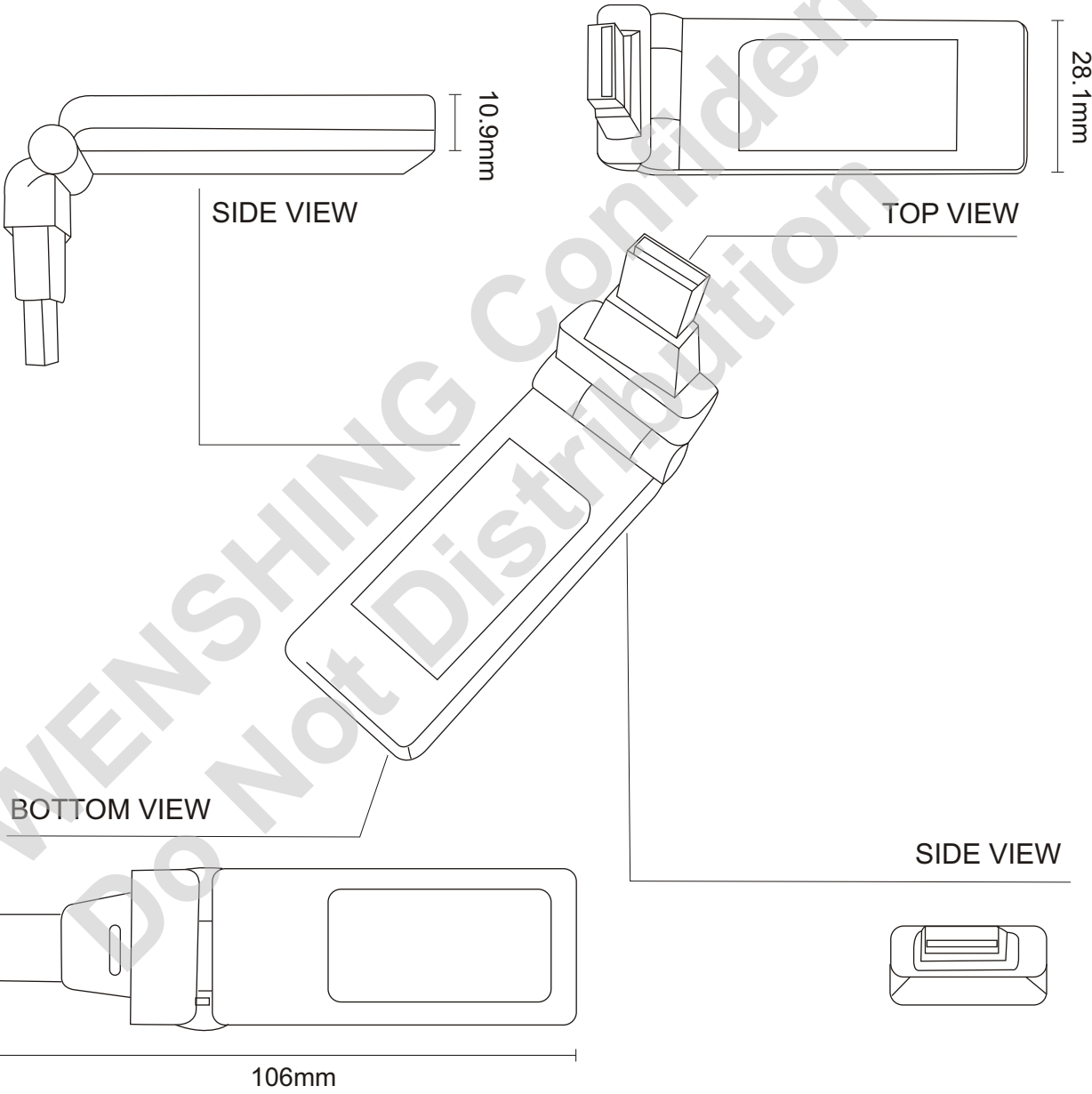



•Turn On

Press  to turn on the device, after successfully connected with the “Wireless Digital USB Receiver” (Hereinafter called USB Receiver), Lamp/Setup will then turn into blue. Once failed to connect or beyond the received range, Lamp/Setup flashes once 2 seconds. As below fig (Fig 1)

•Pair

While the “Wireless Digital Security Camera” (Hereinafter called Camera) is under the standby mode, press Lamp/Setup and last for 4 seconds, Lamp/Setup will then continuously flash in blue. Meanwhile, click the pairing button on the PC screen to process pairing. After Camera was successfully paired with USB Receiver, Lamp/Setup will steadily keep in blue, and images from that camera will be displayed simultaneously on the pc screen. Once Camera was failed to be paired with USB Receiver, Lamp/Setup flashes once 2 seconds. Users may follow the described steps to make pairs again. As below fig (Fig 1)

•Recharge

While  turns into yellow, it means the Camera is running out of battery. Users may now plug in the USB charger, and  will turn into red during recharging. The Camera should be recharged for 3 hours before first-time used, and should be recharged for 1 hour when the battery is low.

Plug in the USB charger here. →

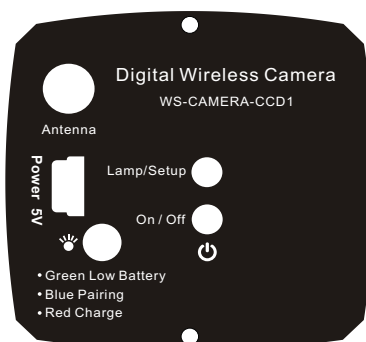

●Install

1.1 Open the “USB Wireless Digital Video” folder. As below fig (Fig 1.1)



(Fig 1.1)

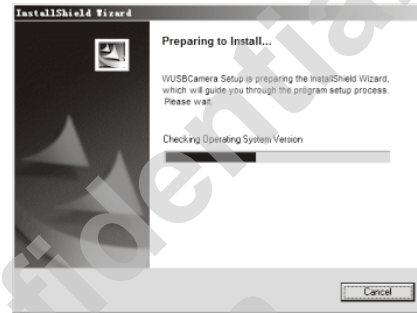

(Fig 1.2)

1.2 Click Setup.exe to process installing procedure. As above (fig. 1.2).

1.3 Click “Next”. As below fig (Fig 1.3)

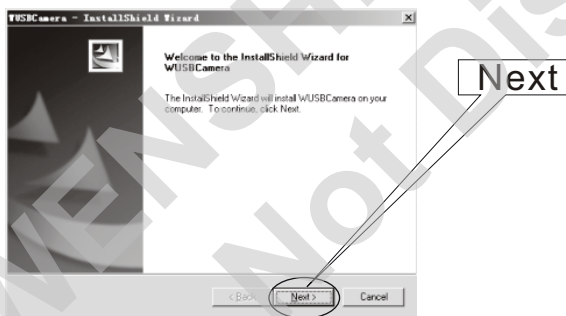

(Fig 1.3)

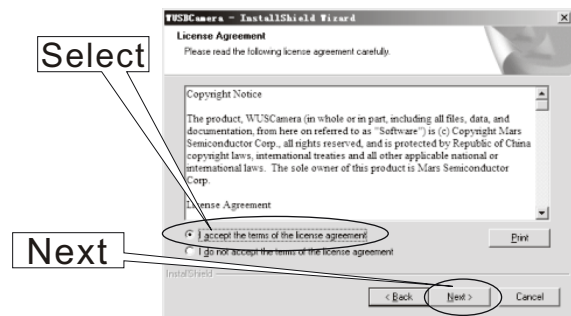

(Fig 1.4)

1.4 Choose “I accept the terms of the license agreement”, and click “Next”. As above fig (Fig 1.4)



(Fig 1.5)

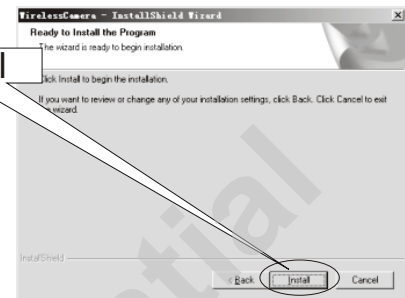

(Fig 1.6)

1.5 Click "Next". As above fig (Fig 1.5)

1.6 Click "Install". As above fig (Fig 1.6)

1.7 Choose "Yes, I want to restart my computer now." click "Finish", and restart the computer. As below fig (Fig 1.7)

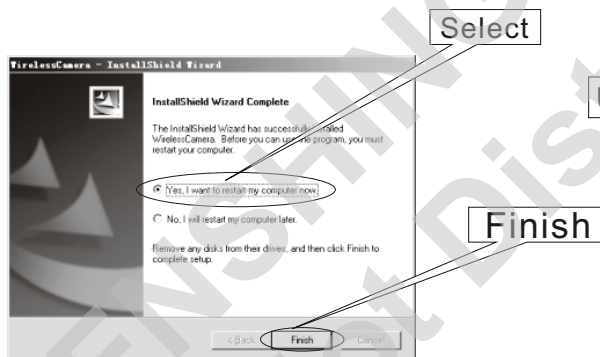

(Fig 1.7)



(Fig 1.8)

1.8 Plug in "USB Receiver", the icon, which is circled, will appear on the lower right side of the desktop. As above fig (Fig 1.8)

1.9 Open up the Task Manager, as long as the "Digital Wireless Camera" as circled shows up, it means this "Wireless Digital USB Receiver" has successfully connected to the computer. As below fig (Fig 1.9)

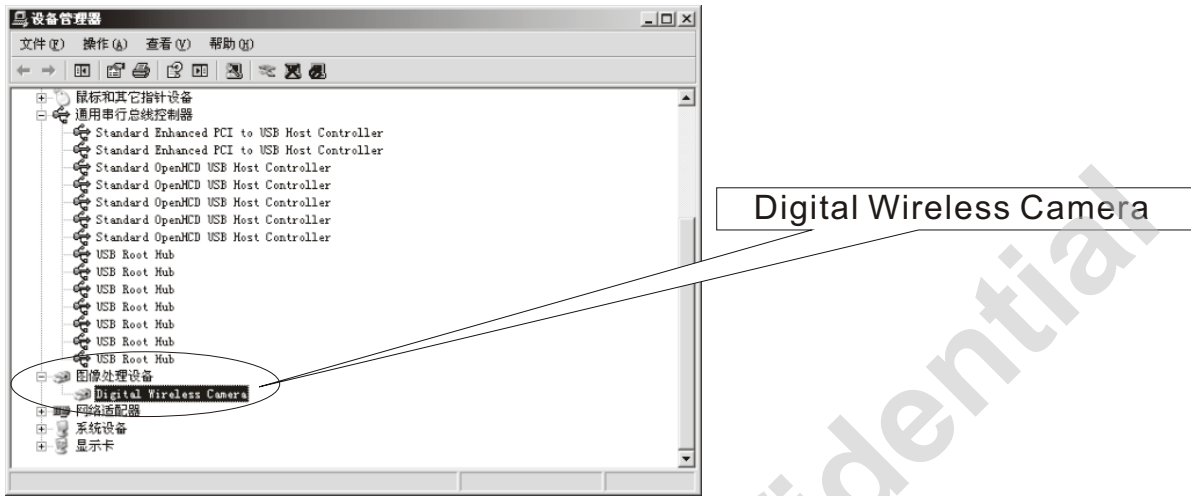

(Fig 1.9)

•Set up

2.1 Click the “CQE” shortcut to start up the software. As below fig (Fig 2.1)

2.2 Download the program. As below fig (Fig 2.2)

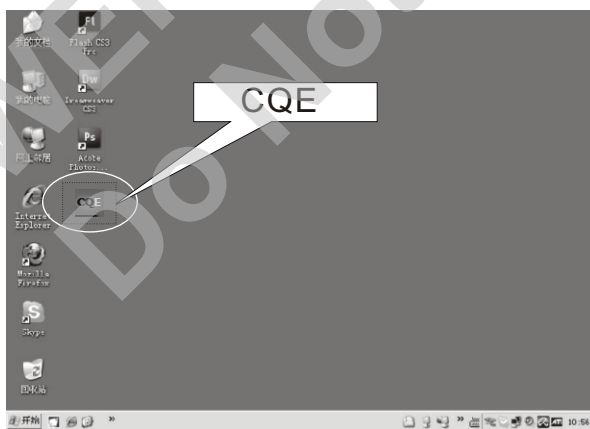

(Fig 2.1)



(Fig 2.2)

2.3 Enter into the surveillance system. As below fig (Fig 2.3)

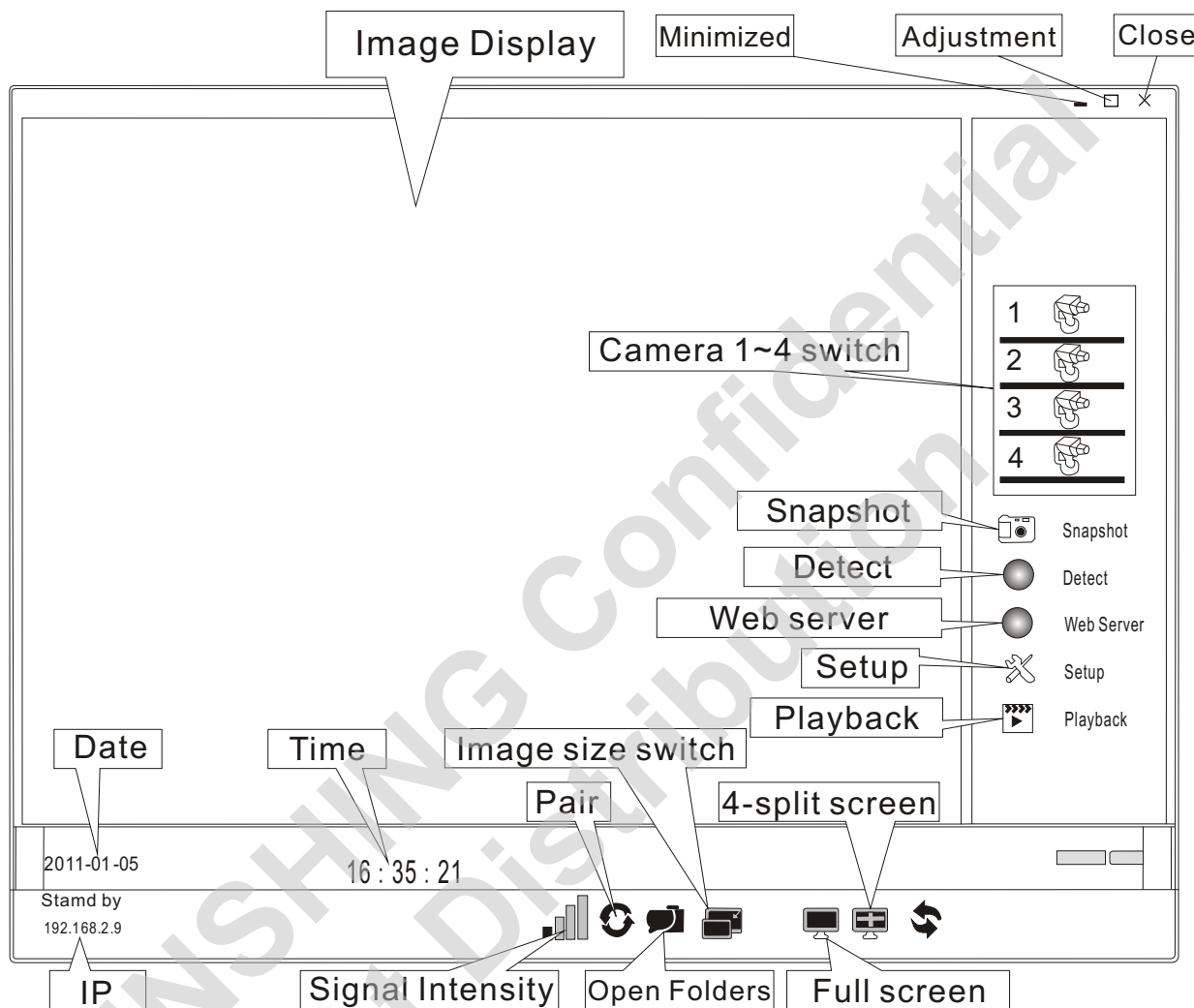

(Fig 2.3)

2.4 Click  Setup to enter into System Settings. As below fig (Fig 2.4)



(Fig 2.4)

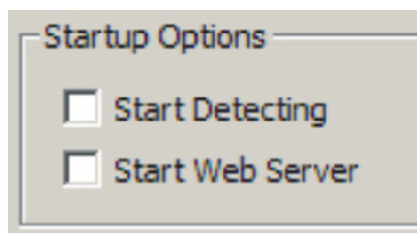

(Fig 2.5)

2.5 Start up Options. As above fig (Fig 2.5)

Check "Start Detecting" to start up the detecting function.

Check "Start Web Server" to start up the Web server function.

When the "Detect" and "Web Server" on step 2.3 were been chosen, "Setup" is not able to be clicked and modify its content. "Setup" will be able to be

Clicked until "Detect" and "Web Server" were not been chosen.

2.6 Storage Location. As below fig (Fig 2.6)

Record: choose location to store videos

Snapshot: choose location to store pictures

Click "... " to set up a new file.

Click "Default" to store files in default folder.

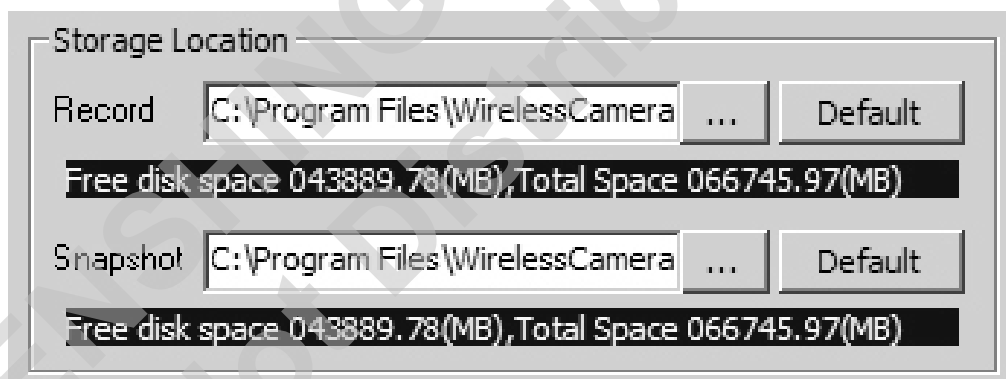

(Fig 2.6)

2.7 Web Server. As below fig (Fig 2.7)

IP Address: The PC searches user's IP automatically

Port: Default 7788

Account: Account name was been set automatically

MMS Server: Port Default 8080

Channel: choose Enable to work the MMS Server.



(Fig 2.7)

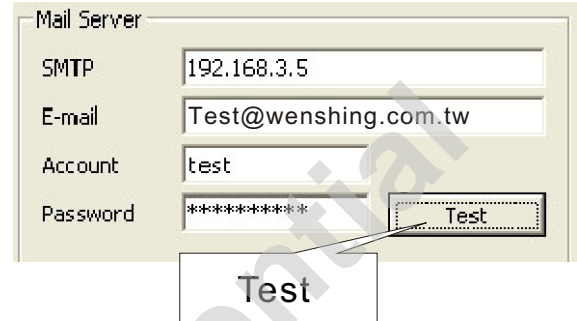

(Fig 2.8)

2.8 Mail Server (Users may key in information based on reality) . As above fig (Fig 2.8)

- SMTP: set by user
- E-mail: set by user
- Account: set by user
- Password: set by user

2.9 After the setting, click “Test”, then the Information pops out. as shown below (Fig. 2.9).

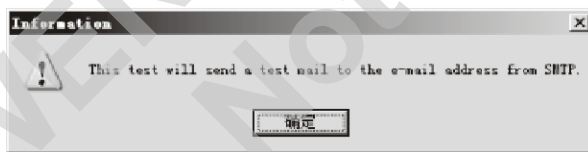

(Fig 2.9)



(Fig 2.11)

2.10 Click “Confirm” to enter into a testing mail.

2.11 The followed information pops out after few seconds, it means the testing mail was failed to be sent seconds. As above fig (Fig 2.11)

2.12 Keep clicking “Test” until the followed information pops out to inform the testing mail has been sent successfully. As below fig (Fig 2.12)



(Fig 2.12)

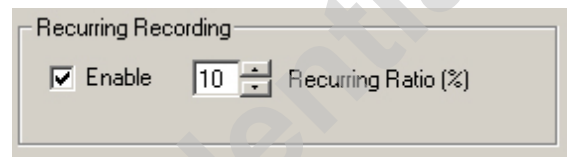

(Fig 2.13)

2.13 Check “Enable” in the Recurring Recording section, and set the Recurring Ratio to “10”. As above fig (Fig 2.13)

2.14 After the setting, click “Apply” to save the memory. As below fig (Fig 2.14)



(Fig 2.14)

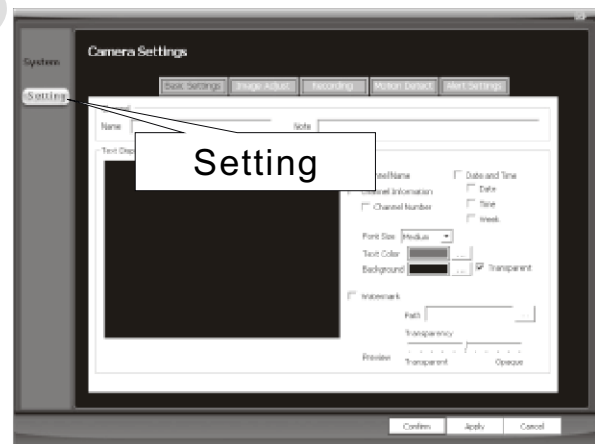

(Fig 2.15)

2.15 Click “Setting”, and enter into the Camera Settings part. As above fig (Fig 2.15)

2.16 Enter the screen shown above (fig. 2.15) to reconfigure “Basic Settings”, as shown below (fig. 2.16).

- ① Name: set to be "myCh01"
- ② Note: set to be "abc"
- ③ Select “Channel Name” to show “myCh01” on the screen. (users may change the definition)
- ④ Check “Date and Time”, and select “Date” / “Time” / “Week” as needed to display on the screen.
- ⑤ Set up the size and color of fonts, and color of background.
- ⑥ Check “Watermark”, Click “...” to choose from user's documents, and adjust the

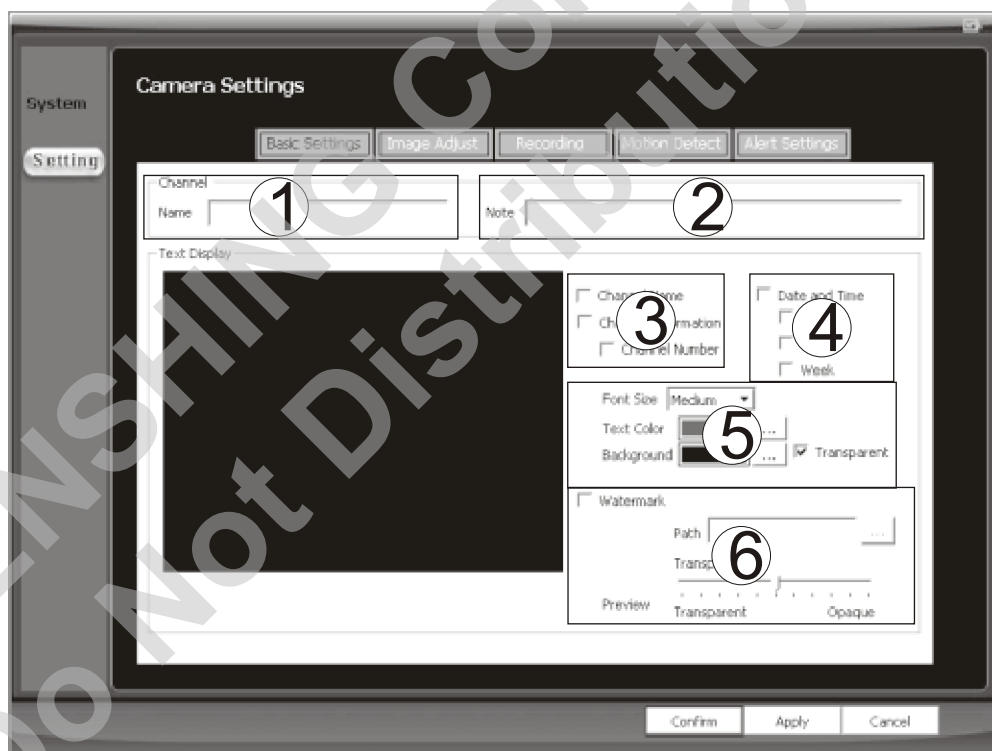

(Fig 2.16)

2.17 Click “Image Adjust” to enter into the image Adjust section. As below fig (Fig 2.17)

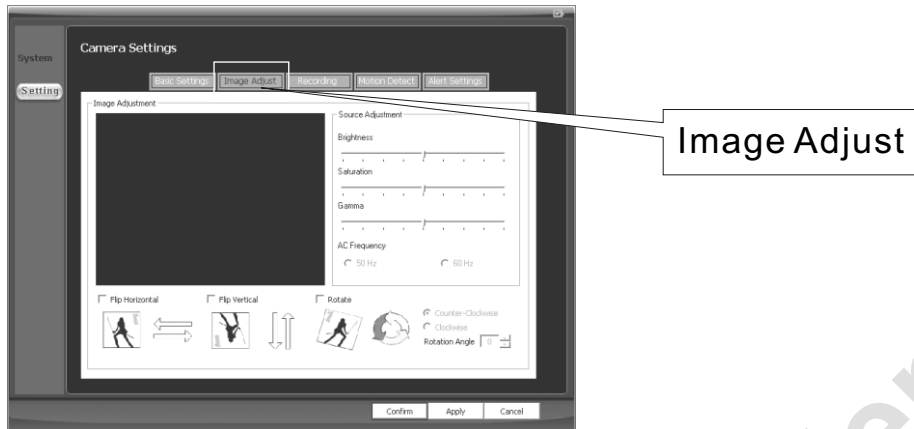

(Fig 2.17)

2.18 Set up parameters

- ①Brightness
- ②Saturation
- ③Gamma
- ④AC Frequency
- ⑤Flip horizontal
- ⑥Flip Vertical
- ⑦Rotate
- ⑧Rotation Angle

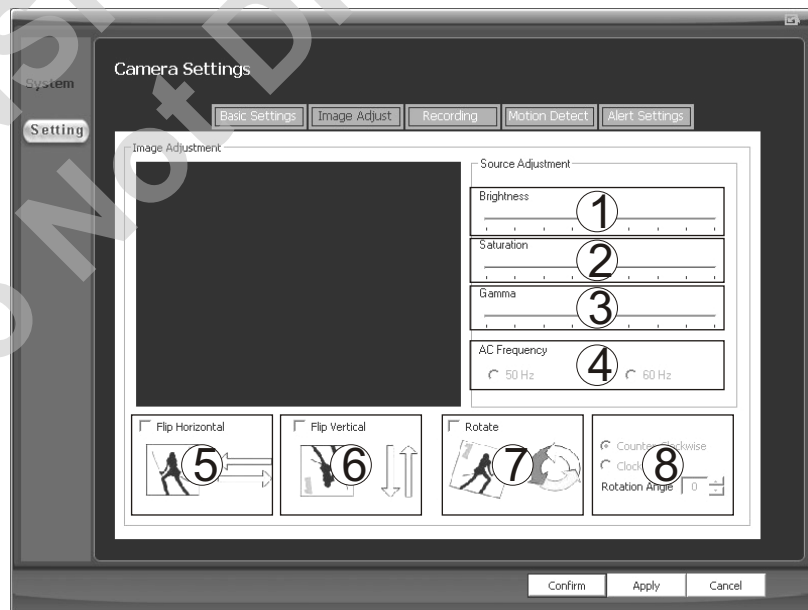

(Fig 2.18)

2.19 Full-time/Triggered mode recording: Click “Recording” and follow the set-up instruction below. As below fig (Fig 2.19)

- ① Set the dimension: 640x480. There are 320x240 or 160x120 two options in addition.
- ② Adjust the Quality.
- ③ Select “Record (During Detection)” in the Surveillance Mode, which means surveillance and recording function exist simultaneously.
- ④ Select Triggered. (the other option “Full-time” means recording continuously)

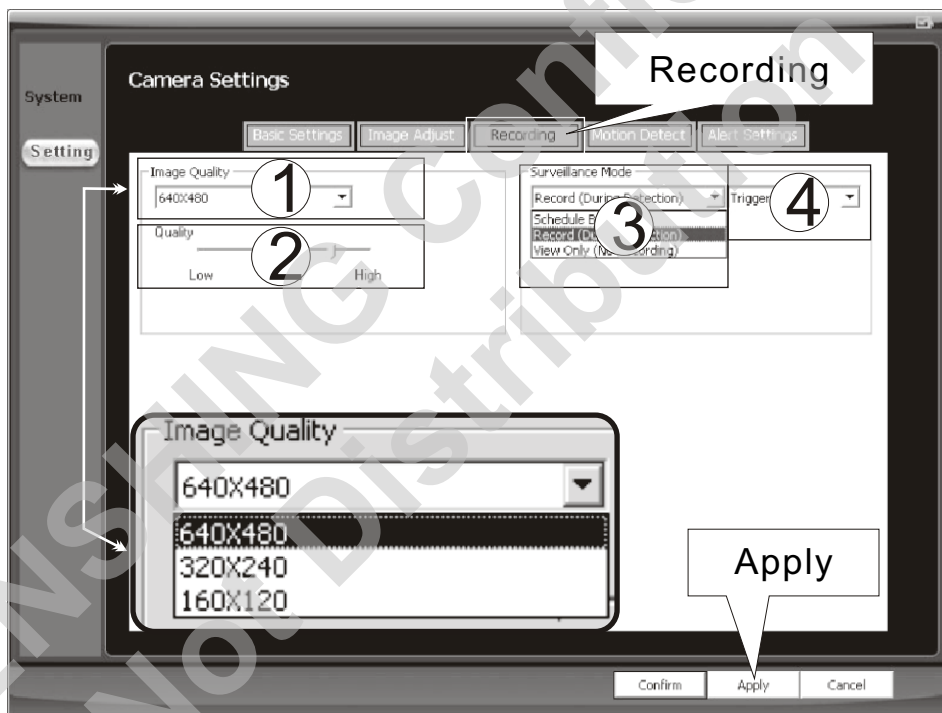

(Fig 2.19)

2.20 Schedule Record: Click on “Recording”, and follow hint 1 and 2 which choose “Schedule Based” and then “Triggered” in the surveillance Mode. After that, click “Add New schedule”. When the page on the lower side appears, choose “Scheduling Type” in circle 3, and set up “Start Date” and “End Date” in circle 4. Click “Apply” and “Confirm” to memorize the setting.



(Fig 2.20)

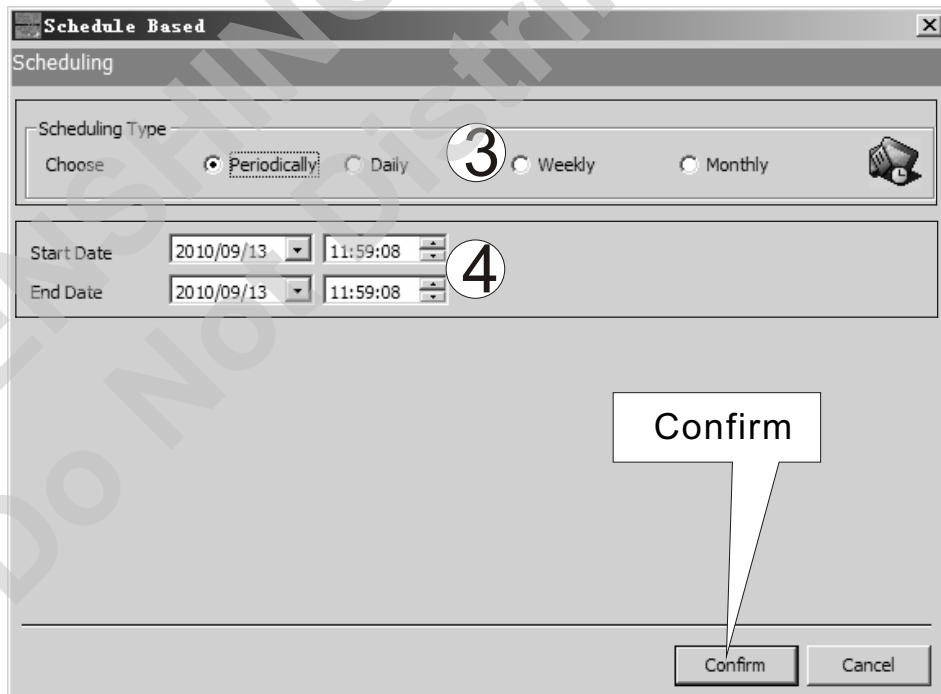

(Fig 2.20-1)

2.21 Click on “Motion Detect” to enter and configure, and click on “Refresh View” to preview, as shown below (Fig. 2.21).

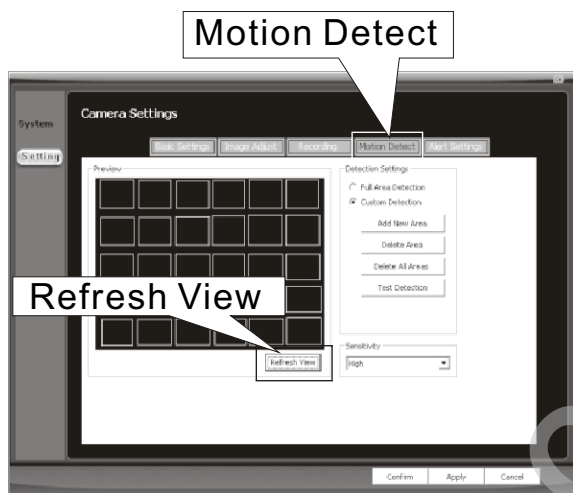

(Fig 2.21)



(Fig 2.22)

2.22 Click “Alert Setting” to enter into the section. As above fig (Fig 2.22)

2.23 Click “confirm” after setting the parameters, and exit from the section. As below fig (Fig 2.23)

- ① Check “Enable Vibrate Window” to turn on the vibration alarm.
- ② Check “Enable” to turn on the Message Alert.
- ③ Check “ Enable” to turn on voice alarm, then choose from Default Sound1~3, or “Custom” to attach document from users files by clicked on “...”. Click “Test” to test the result.
- ④ Check “Enable” to turn on E-mail Alert, the parameters can be set based on reality.

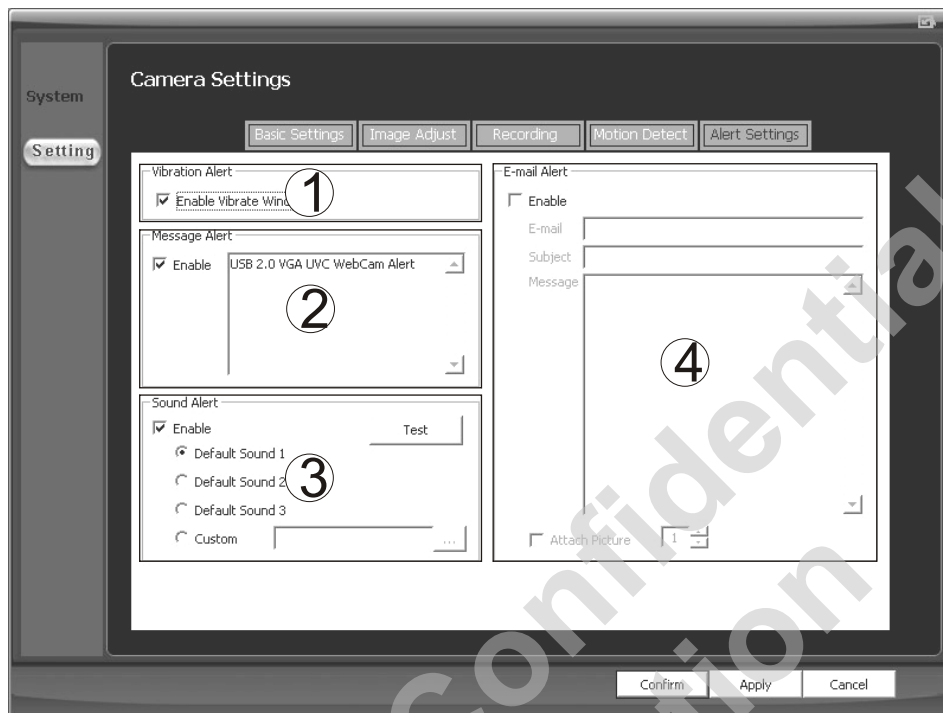

(Fig 2.23)

2.24 Due to some PC driver do not support, in order to record voice as well, Audio In and Audio out wires are needed to be connected to PC (or plugging in both microphone and speaker to PC). As below fig (Fig 2.24)



(Fig 2.24)

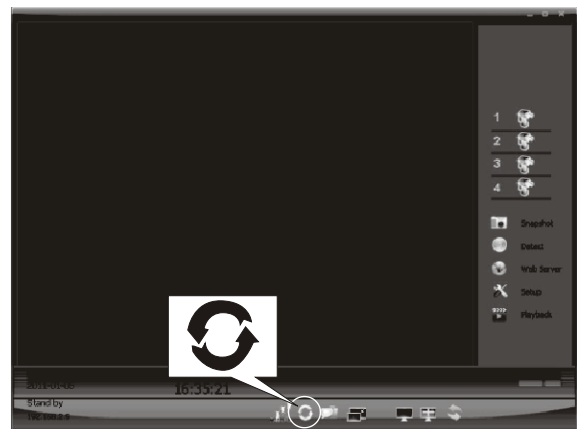

(Fig 3.1)

•Pair

3.1 Click  to process paring. As above fig (Fig 3.1)

3.2 Click Camera 1 to process searching. As below fig (Fig 3.2)

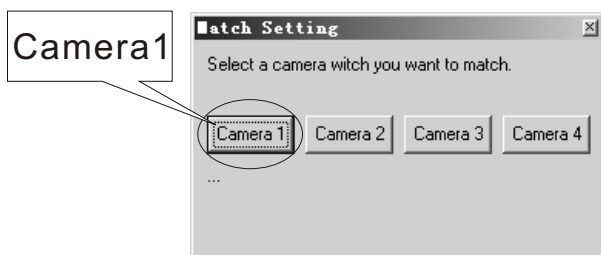

(Fig 3.2)

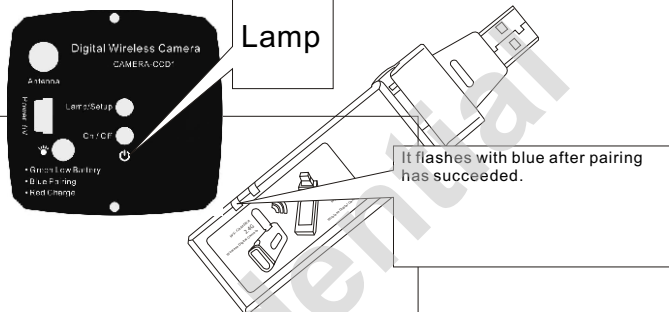

(Fig 3.3)

3.3 While the Camera is under the standby mode, press Lamp/Setup and last 4 seconds, Lamp/Setup will then continuously flash in blue. Meanwhile, click the pairing button on the PC screen to process pairing. After Camera was successfully paired with USB Receiver, Lamp/Setup will keep in blue, and images from that camera display simultaneously on the pc screen. Once failed to pair with USB Receiver, Lamp/Setup flashes once 2 seconds. User may follow the above steps to make pairs again. As above fig (Fig 3.3)

3.4 If search failed, users will be informed by the notification "Match complete, no camera detected" . As below fig (Fig 3.4)

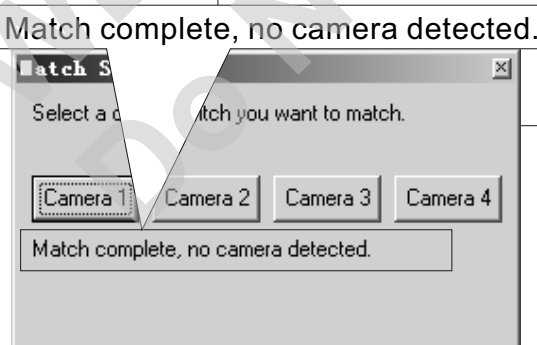

(Fig 3.4)

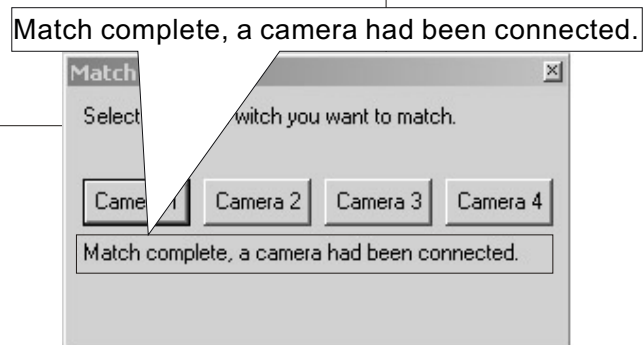

(Fig 3.5)

3.5 Once pairing has succeeded, "Match complete, a camera had been connected" shows up. As above fig (Fig 3.5)

3.6 Click Camera 2 / Camera 3 /Camera 4 to process searching and repeat step 3.1. As shown below (Fig. 3.6)

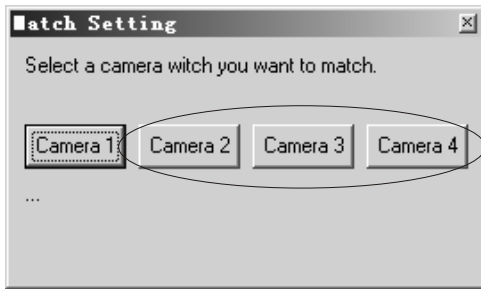

(Fig 3.6)



(Fig 4.1)

●Application

4.1 After pairing succeeded, signal intensity  shows up in the lower side of the screen. Images captured from Camera 1 then appear on the Image Display area. As above fig (Fig 4.1)

4.2 Click 2  to switch to images from camera 2. As shown below (Fig. 4.2)



(Fig 4.2)



(Fig 4.3)

4.3 Click3  to switch to images from camera 3. As shown above (Fig. 4.2)

4.4 Click 4  to switch to images from Camera 4. As shown below (Fig. 4.4)



(Fig 4.4)



(Fig 4.5)

4.5 Click  to switch to the 4-split screen, which means display images from the 4 cameras simultaneously. As above fig (Fig 4.5)

4.6 While the display area belongs to single camera, click  Snapshot to take a snapshot, and save the document to pre-set file under the name of date. As below fig (Fig 4.6)



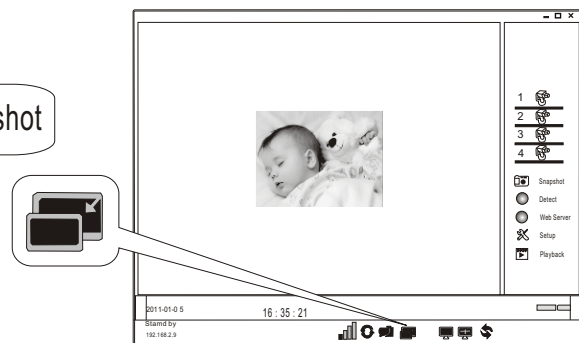

(Fig 4.6)



(Fig 4.7)

4.7 Click  to narrow down the image. As above fig (Fig 4.7)



4.8 Users may keep clicking  to the minimized, then  click again to enlarge back gradually to the original size . As above fig (Fig 4.7)





(Fig 4.8)



(Fig 4.9)

4.9 While the display area belongs to one single camera (as picture 4.8), click  to switch to mini screen, and users may click  to return to original screen size. As shown above fig (Fig. 4.9)

4.10 Click  Detect to start recording, and the free disk space and Total space will be shown on the lower side of the status bar then. Click  Detect again to stop recording. As below fig (Fig 4.10)



(Fig 4.10)

4.11 Click  Playback to enter into Record List. As below fig (Fig 4.11)

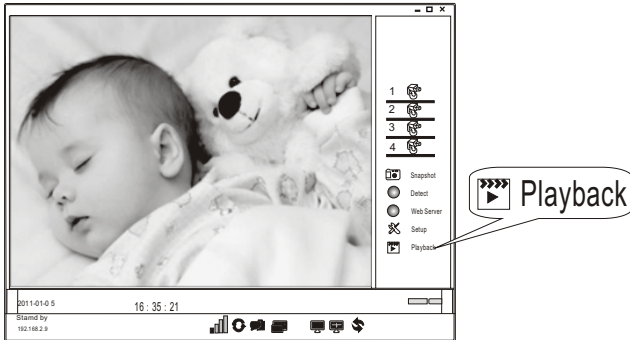

(Fig 4.11)

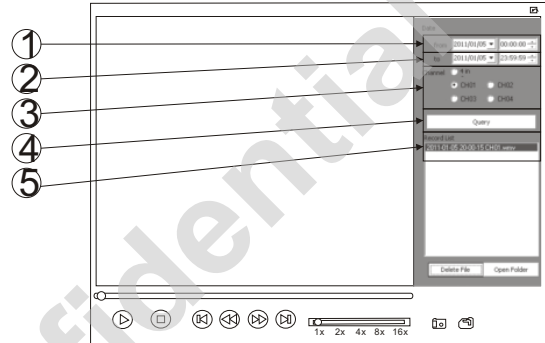

(Fig 4.12)

4.12 Users may choose one channel and set up the date and time when to start and end the recording, and click “Query”, the date appointed record file will then show up on the Record List. As above fig (Fig 4.9)

4.13 Click the file on the “Record List” to start the display. Users may use the control buttons or speed control bar. As below fig(Fig 4.13)

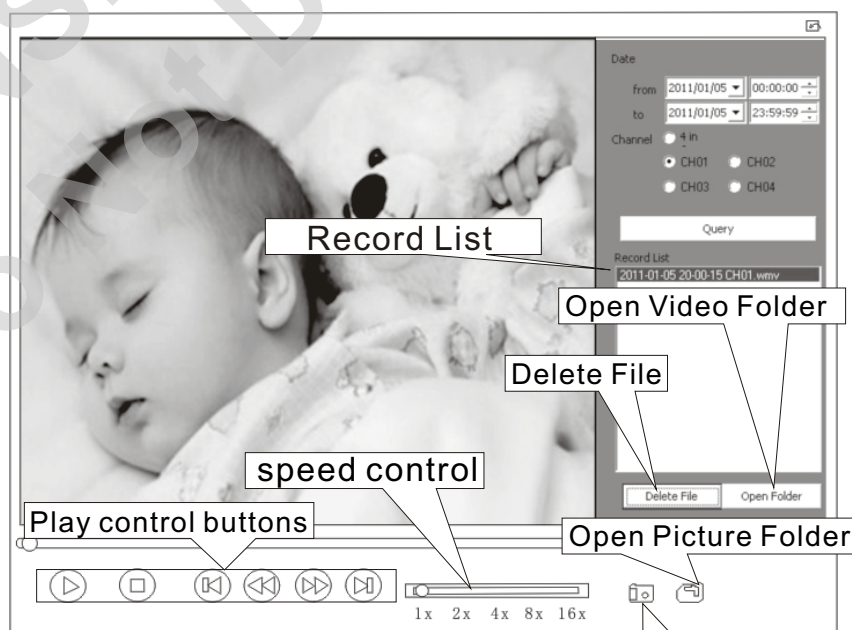

(Fig 4.13)

4.14 Click “Open Folder” to open video folders. As below fig (Fig 4.14)



(Fig 4.14)



(Fig 4.15)

4.15 Click  to unfold pic folder. As above fig (Fig 4.15)

4.16 Click  to return to surveillance mode. As below fig (Fig 4.16)

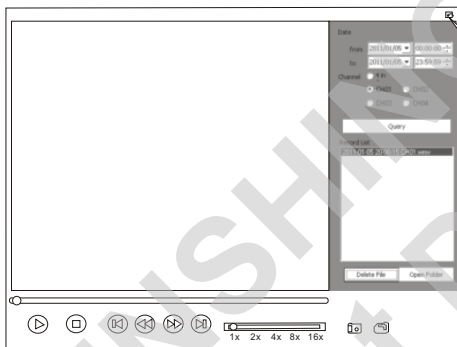

(Fig 4.16)



(Fig 5.1)

•Internet Surveillance

5.1 Click  Web Server to turn on the Web server. As above fig (Fig 5.1)

5.2 Key in http://IP: Port Number (Your computer IP and Port Number) as website address, and press “Enter”, then type user name and pass word“123456”. The message box will not appear if users did not set the pass word. As below fig (Fig 5.2)

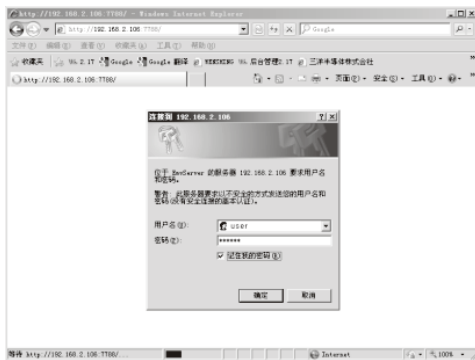

(Fig 5.2)

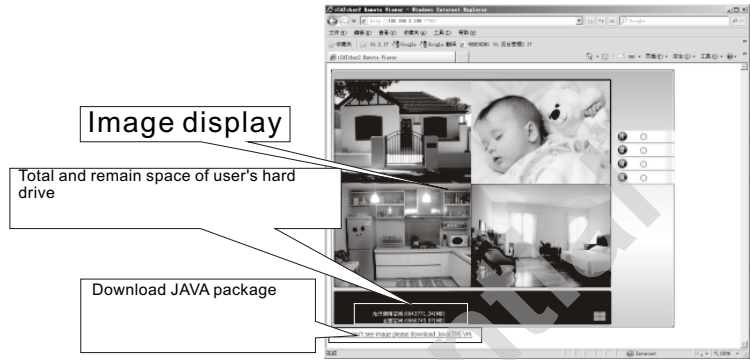

(Fig 5.3)

5.3 After the setting, users will enter into the internet surveillance page, if not, please go to <http://www.java.com/en/> and download the Java package. As above fig (Fig 5.3)

●Abnormal Test

6.1 If the “Wireless Digital USB Receiver” is not plugged in to the computer, it will display an error. As below fig (Fig 6.1)



(Fig 6.1)



(Fig 6.2)

6.2 Click “Confirm” to check the hint. As above fig (Fig. 6.2)

6.3 Click “Confirm” to enter into the page below. As below fig (Fig 6.3)



(Fig 6.3)

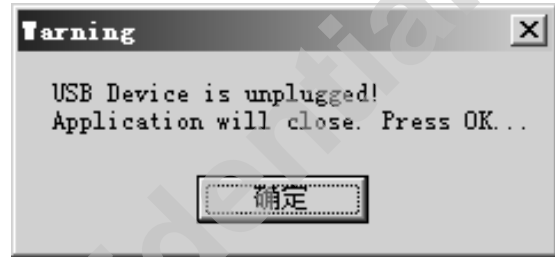

(Fig 6.4)

6.4 If the “wireless digital audio video USB controller” was plugged out while running a normality test, a reminder screen will pop up as shown above (Fig. 6.4)

Attention: FCC rule regulation, modified and changed must allowed by WENSHING Electronics company, otherwise that would make you operate this apparatus invalid. This apparatus adopted test, according to chapter 15 that FCC regulation, accord with Class B digital restrictions of device. These limits are designed to provide reasonable protection, avoid to having harmful interference at home's environment.

This device may have radiated wireless frequency energy. If don't allow the instruction manual, then may will interfere wireless communication. However, there is no any way to guarantee, it will not be interfered in particular installed. If this device really causes harmful interference, (It could be confirmed by turning on or off this device.) Advise you to try to use the following ways modifying the interference situation.

✎ Relocation receiving antenna or altering its direction.

✎ Increase the distance between device and receiver.

✎ Please connect this device to the outlet in the circuit different from the receiver.

✎ The following manuals is published by Federal Communications Commission, they must be helpful to all users.

✎ How to Identify and Resolve Radio-TV Interference Problems. (This manual can be obtained by relevant departments of publication of the U.S. government.)

✎ Government Printing Office, Washington D.C., 20402. Stock No. 004-00398-5

Notice: The changes or modifications not expressly approved by the party responsible for compliance could void the user's authority to operate the equipment.

IMPORTANT NOTE: To comply with the FCC RF exposure compliance requirements, no change to the antenna or the device is permitted. Any change to the antenna or the device could result in the device exceeding the RF exposure requirements and void user's authority to operate the device.

Administrative Regulations on Low Power Radio Waves Radiated Devices

Article 12

Without permission granted by the DGT, any company, enterprise, or user is not allowed to change frequency, enhance transmitting power or alter original characteristic as well as performance to a approved low power radio-frequency devices.

Article 14

The low power radio-frequency devices shall not influence aircraft security and interfere legal communications; If found, the user shall cease operating immediately until no interference is achieved.

The said legal communications means radio communications is operated in compliance with the Telecommunications Act.

The low power radio-frequency devices must be susceptible with the interference